

M12 male 90° / M12 male 90° 8p. shielded EN

TPE 4x2x24AWG SF/UTP CAT5e bu UL/CSA, CM 0,6m

Male 90° – male 90°

The resistance to aggressive media should be individually tested for your application. Further details on request.

Further cable lengths on request.

M12 – M12, 8-pole

shielded

USA

without cable sleeves

Ethernet CAT5

Ethernet CAT5e

Cable is approved for 600 V

Plastic housings with good resistance against chemicals and oils.

[Link to Product](#)

Illustration

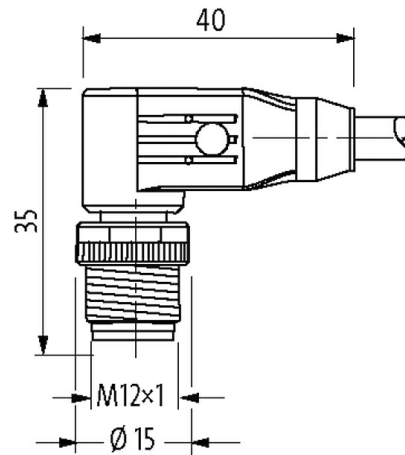

1	white/blue	1
2	white/brown	2
3	brown	3
4	orange	4
5	white/green	5
6	white/orange	6
7	blue	7
8	green	8
shield		

Male

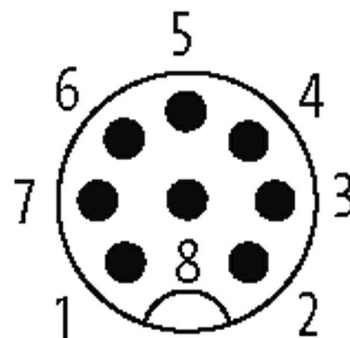

Product may differ from Image

Approvals



* only for products with UL/CSA approved cable

More Info

EtherNet/IP

Form

Form 48561

General data

Standards	DIN EN 61076-2-101 (M12)
Mounting method	inserted, tightened
Pollution Degree	2
Temperature range	-25...+85 °C, depending on cable quality

Cables

No./diameter of wires	4 × 2 × 0.25 mm ²
Wire isolation	HDPE (whbl, bl, whor, or, whgn, gn, whbr, br)
C-track properties	1 Mio.
Jacket Color	blue
Material (jacket)	TPE (UL/CSA)
Outer Ø	7.6 mm ±5%
Bend radius (moving)	10 × outer Ø
Temperature range (fixed)	-40...+80 °C
Temperature range (mobile)	-40...+80 °C
Cable identification	S4W
Cable weight [g/m]	74,80
Material (wire)	Cu wire, tin plated
Construction (core)	7 × 0.203 mm
Diameter (core)	4 × 2 × 0.25 mm ²
AWG	similar to AWG 24
Material (wire isolation)	HDPE
Wire-Ø incl. isolation	1.17 mm ±5%
Color/numbering of wires	(wh-bl, bl) + (wh-or, or) + (wh-gn, gn) + (wh-br, br)
Shield	yes
	min. 75%
Material (jacket)	TPE
Outer-Ø (jacket)	7.6 mm ±5%
Color (jacket)	(wh-bl, bl) + (wh-or, or) + (wh-gn, gn) + (wh-br, br)
Temperature range (fixed)	-40...+80 °C
Temperature range (mobile)	-40...+80 °C
Bend radius (fixed)	5 × outer Ø
No. of bending cycles (C-track)	max. 1 Mio. (25 °C)
Torsion stress	3 Mio.

Technical Data

Operating voltage max. 60 V AC/DC

Operating voltage (only UL listed)	30 V AC/DC
Rated surge voltage	0.8 kV
Operating current per contact	max. 2 A
Material group	IEC 60664-1, category I
No. of poles	8
Configuration	fully used
Transfer parameters	CAT5, Class D (ISO/IEC 11801:2002), (EN 50173-1)
Transfer rate	1 Gbit/s
Coding	A-coded
LED display	no
Locking of ports	Screw thread (M12×1 mm) recommended torque 0.6 Nm, self-securing
Compression gland	M12 (SW13)
Protection	IP65 and IP67 when plugged and screwed down (EN 60529)
Locking material	Zinc die casting, matte nickel plated
Material	PUR
suitable for corrugated tube (internal Ø)	without

Commercial data

country of origin	DE
customs tariff number	85444290
EAN	4048879600125
eClass	27061801
Packaging unit	1